



## VERY LOW DROP 1.5 A REGULATORS

- PRECISE 5 V, 8.5 V, 10 V, 12 V OUTPUTS
- LOW DROPOUT VOLTAGE (500 mV typ at 1.5A)
- VERY LOW QUIESCENT CURRENT
- THERMAL SHUTDOWN
- SHORT CIRCUIT PROTECTION
- REVERSE POLARITY PROTECTION

### DESCRIPTION

The L4940 series of three terminal positive regulators is available in TO-220 and D<sup>2</sup>PAK package and with several fixed output voltages, making it useful in a wide range of industrial and consumer applications. Thanks to its very low input/output voltage drop, these devices are particularly suitable for battery powered equipments, reducing consumption and prolonging battery life. Each type employs internal current limiting, antisaturation circuit, thermal shut-down and safe area protection.

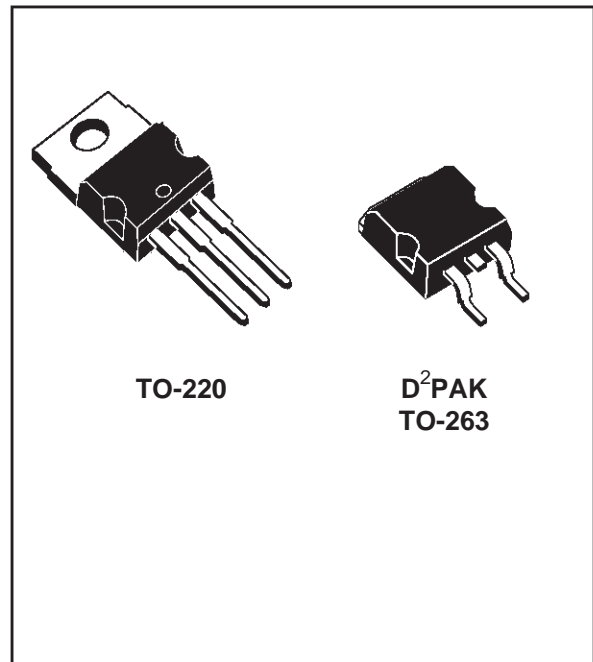

### BLOCK DIAGRAM

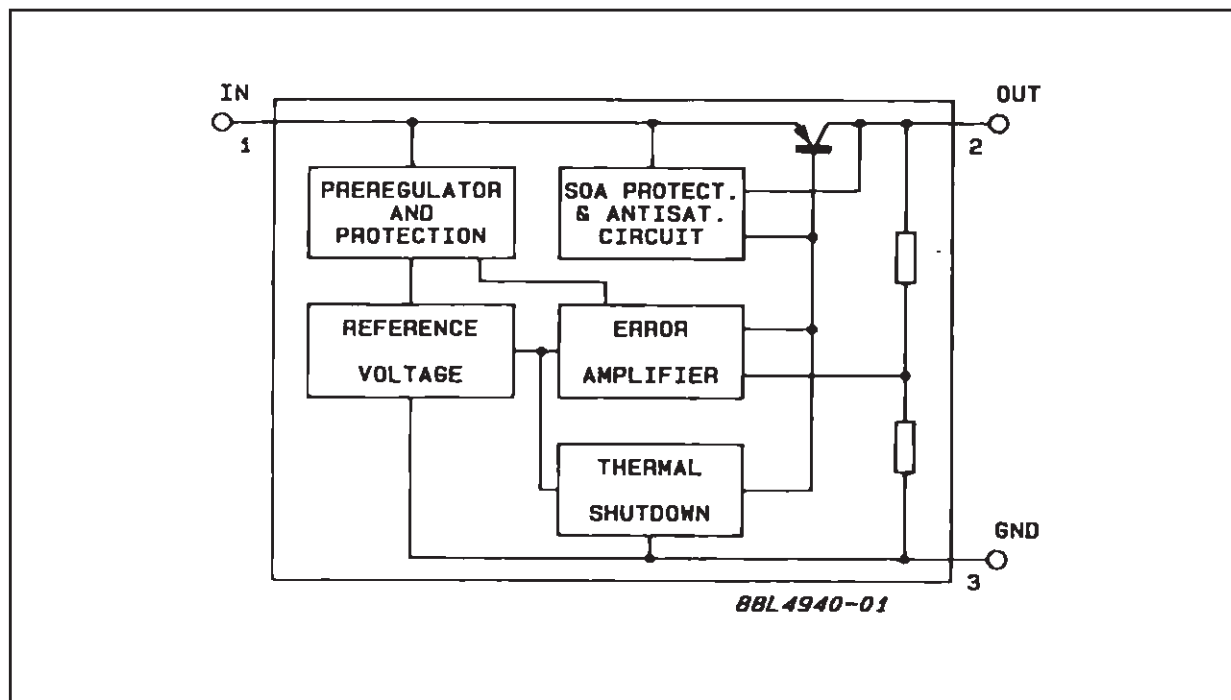

## L4940 series

### PIN CONNECTION AND ORDER CODES

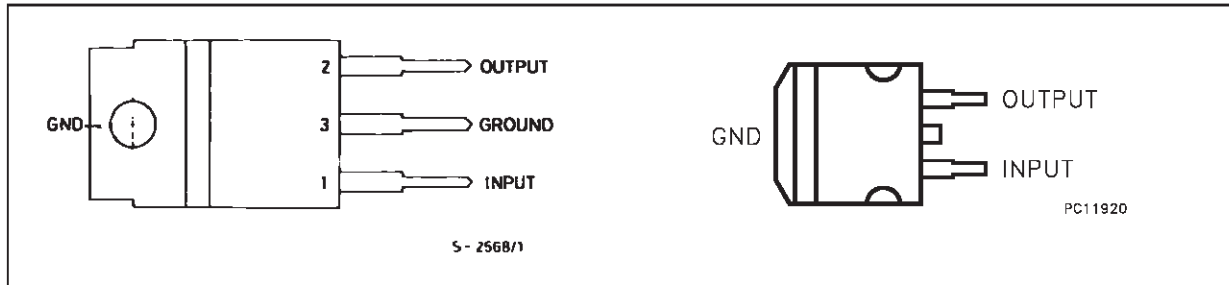

ORDERING NUMBERS		OUTPUT VOLTAGE
TO-220	D <sup>2</sup> PAK	
L4940V5	L4940D2T5	5V
L4940V85	L4940D2T85	8.5V
L4940V10	L4940D2T10	10V
L4940V12	L4940D2T12	12V

### ABSOLUTE MAXIMUM RATING

Symbol	Description	Values	Unit	
$V_I$	Forward Input Voltage	30	V	
$V_{IR}$	Reverse Input Voltage	$V_O = 5\text{ V}$ $R_O = 100\ \Omega$	-15	V
		$V_O = 8.5\text{ V}$ $R_O = 180\ \Omega$		
		$V_O = 10\text{ V}$ $R_O = 200\ \Omega$		
		$V_O = 12\text{ V}$ $R_O = 240\ \Omega$		
$I_O$	Output Current	Internally Limited		
$P_{tot}$	Power Dissipation	Internally Limited		
$T_j, T_{stg}$	Junction and Storage Temperature	-40 to 150	°C	

### THERMAL DATA

Symbol	Description	Value		Unit
		TO-220	D <sup>2</sup> PAK	
$R_{thj-case}$	Thermal Resistance Junction-case Max	3	3	°C/W
$R_{thj-amb}$	Thermal Resistance Junction-ambient Max	50	62.5	°C/W

## TEST CIRCUITS

Figure 1 : DC Parameter.

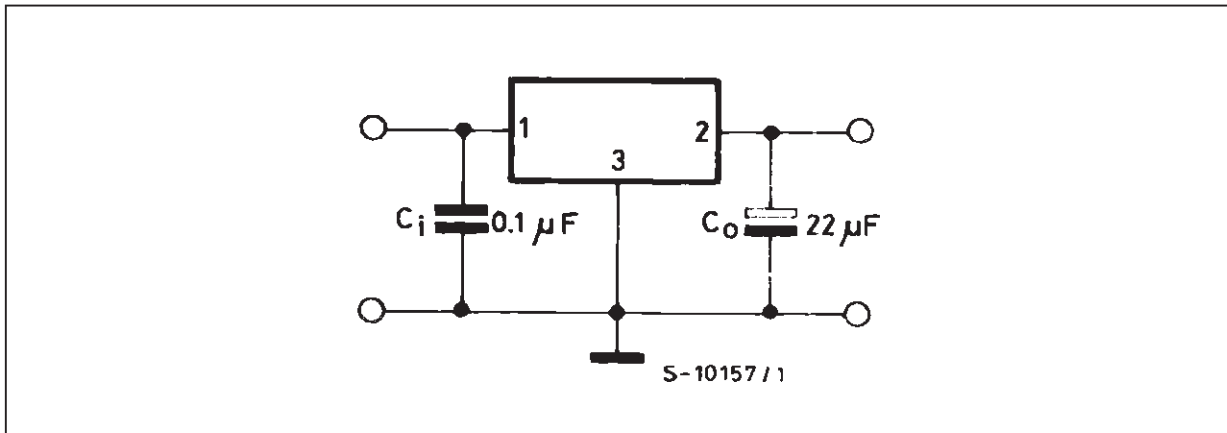

Figure 2 : Load Rejection.

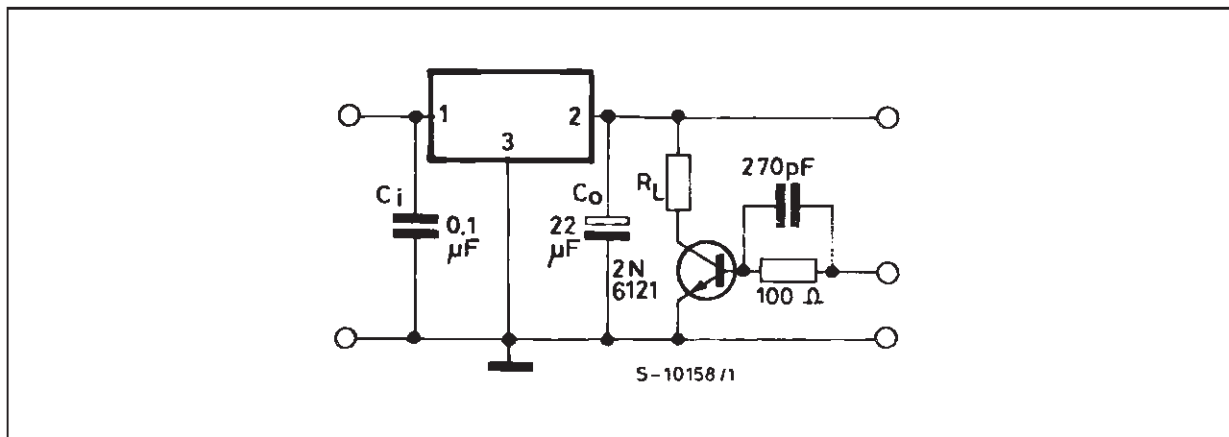
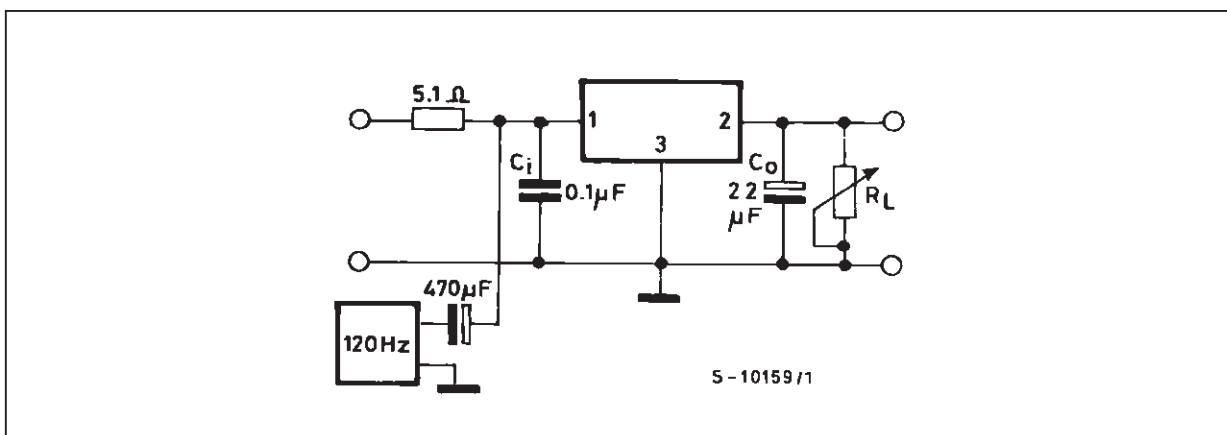

Figure 3 : Ripple Rejection.



## L4940 series

**ELECTRICAL CHARACTERISTICS FOR L4940V5** (refer to the test circuits,  $T_j = 25\text{ }^\circ\text{C}$ ,  
 $V_i = 7\text{V}$ ,  $C_i = 0.1\text{ }\mu\text{F}$ ,  $C_o = 22\text{ }\mu\text{F}$  unless otherwise specified)

Symbol	Parameter	Test Conditions	Min.	Typ.	Max.	Unit
$V_o$	Output Voltage	$I_o = 500\text{ mA}$	4.9	5	5.1	V
$V_o$	Output Voltage	$I_o = 5\text{ mA to }1500\text{ mA}$ $V_i = 6.5\text{ to }16\text{ V}$	4.8	5	5.2	V
$V_i$	Operating Input Voltage	$I_o = 5\text{ mA}$			17	V
$\Delta V_o$	Line Regulation	$I_o = 5\text{ mA}$ $V_i = 6\text{ to }17\text{ V}$		4	10	mV
$\Delta V_o$	Load Regulation	$I_o = 5\text{ to }1500\text{ mA}$ $I_o = 500\text{ to }1000\text{ mA}$		8 5	25 15	mV
$I_Q$	Quiescent Current	$I_o = 5\text{ mA}$ $I_o = 1.5\text{ A}$ $V_i = 6.5\text{ V}$		5 30	8 50	mA
$\Delta I_Q$	Quiescent Current Change	$I_o = 5\text{ mA}$ $I_o = 1.5\text{ A}$ $V_i = 6.5\text{ to }16\text{ V}$			3 15	mA
$\frac{\Delta V_o}{\Delta T}$	Output Voltage Drift			0.5		mV/ $^\circ\text{C}$
SVR	Supply Voltage Rejection	$I_o = 1\text{ A}$ $f = 120\text{ Hz}$	58	68		dB
$V_d$	Dropout Voltage	$I_o = 0.5\text{ A}$ $I_o = 1.5\text{ A}$		200 500	400 900	mV
$I_{sc}$	Short Circuit Current	$V_i = 14\text{ V}$ $V_i = 6.5\text{ V}$		2 2.2	2.7 2.9	A

**ELECTRICAL CHARACTERISTICS FOR L4940V85** (refer to the test circuits,  $T_j = 25\text{ }^\circ\text{C}$ ,  
 $V_i = 10.5\text{V}$ ,  $C_i = 0.1\text{ }\mu\text{F}$ ,  $C_o = 22\text{ }\mu\text{F}$  unless otherwise specified)

Symbol	Parameter	Test Conditions	Min.	Typ.	Max.	Unit
$V_o$	Output Voltage	$I_o = 500\text{ mA}$	8.3	8.5	8.7	V
$V_o$	Output Voltage	$I_o = 5\text{ mA to }1500\text{ mA}$ $V_i = 10.2\text{ to }16\text{ V}$	8.15	8.5	8.85	V
$V_i$	Operating Input Voltage	$I_o = 5\text{ mA}$			17	V
$\Delta V_o$	Line Regulation	$I_o = 5\text{ mA}$ $V_i = 9.5\text{ to }17\text{ V}$		4	9	mV
$\Delta V_o$	Load Regulation	$I_o = 5\text{ to }1500\text{ mA}$ $I_o = 500\text{ to }1000\text{ mA}$		12 8	30 16	mV
$I_Q$	Quiescent Current	$I_o = 5\text{ mA}$ $I_o = 1.5\text{ A}$ $V_i = 10.2\text{ V}$		4 30	8 50	mA
$\Delta I_Q$	Quiescent Current Change	$I_o = 5\text{ mA}$ $I_o = 1.5\text{ A}$ $V_i = 10.2\text{ to }16\text{ V}$			2.5 15	mA
$\frac{\Delta V_o}{\Delta T}$	Output Voltage Drift			0.8		mV/ $^\circ\text{C}$
SVR	Supply Voltage Rejection	$I_o = 1\text{ A}$ $f = 120\text{ Hz}$	58	66		dB
$V_d$	Dropout Voltage	$I_o = 0.5\text{ A}$ $I_o = 1.5\text{ A}$		200 500	400 900	mV
$I_{sc}$	Short Circuit Current	$V_i = 14\text{ V}$ $V_i = 10.2\text{ V}$		2 2.2	2.7 2.9	A

**ELECTRICAL CHARACTERISTICS FOR L4940V10** (refer to the test circuits,  $T_j = 25\text{ }^\circ\text{C}$ ,  
 $V_i = 12\text{ V}$ ,  $C_i = 0.1\text{ }\mu\text{F}$ ,  $C_o = 22\text{ }\mu\text{F}$  unless otherwise specified)

Symbol	Parameter	Test Conditions	Min.	Typ.	Max.	Unit
$V_o$	Output Voltage	$I_o = 500\text{ mA}$	9.8	10	10.2	V
$V_o$	Output Voltage	$I_o = 5\text{ mA to }1500\text{ mA}$ $V_i = 11.7\text{ to }16\text{ V}$	9.6	10	10.4	V
$V_i$	Operating Input Voltage	$I_o = 5\text{ mA}$			17	V
$\Delta V_o$	Line Regulation	$I_o = 5\text{ mA}$ $V_i = 11\text{ to }17\text{ V}$		3	8	mV
$\Delta V_o$	Load Regulation	$I_o = 5\text{ to }1500\text{ mA}$ $I_o = 500\text{ to }1000\text{ mA}$		15 10	35 20	mV
$I_Q$	Quiescent Current	$I_o = 5\text{ mA}$ $I_o = 1.5\text{ A}$ $V_i = 11.7\text{ V}$		4 30	8 50	mA
$\Delta I_Q$	Quiescent Current Change	$I_o = 5\text{ mA}$ $I_o = 1.5\text{ A}$ $V_i = 11.7\text{ to }16\text{ V}$			2 13	mA
$\frac{\Delta V_o}{\Delta T}$	Output Voltage Drift			1		mV/ $^\circ\text{C}$
SVR	Supply Voltage Rejection	$I_o = 1\text{ A}$ $f = 120\text{ Hz}$	56	62		dB
$V_d$	Dropout Voltage	$I_o = 0.5\text{ A}$ $I_o = 1.5\text{ A}$		200 500	400 900	mV
$I_{sc}$	Short Circuit Current	$V_i = 14\text{ V}$ $V_i = 11.7\text{ V}$		2 2.2	2.7 2.9	A

**ELECTRICAL CHARACTERISTICS FOR L4940V12** (refer to the test circuits,  $T_j = 25\text{ }^\circ\text{C}$ ,  
 $V_i = 14\text{ V}$ ,  $C_i = 0.1\text{ }\mu\text{F}$ ,  $C_o = 22\text{ }\mu\text{F}$  unless otherwise specified)

Symbol	Parameter	Test Conditions	Min.	Typ.	Max.	Unit
$V_o$	Output Voltage	$I_o = 500\text{ mA}$	11.75	12	12.25	V
$V_o$	Output Voltage	$I_o = 5\text{ mA to }1500\text{ mA}$ $V_i = 13.8\text{ to }17\text{ V}$	11.5	12	12.5	V
$V_i$	Operating Input Voltage	$I_o = 5\text{ mA}$			17	V
$\Delta V_o$	Line Regulation	$I_o = 5\text{ mA}$ $V_i = 13\text{ to }17\text{ V}$		3	7	mV
$\Delta V_o$	Load Regulation	$I_o = 5\text{ to }1500\text{ mA}$ $I_o = 500\text{ to }1000\text{ mA}$		15 10	35 25	mV
$I_Q$	Quiescent Current	$I_o = 5\text{ mA}$ $I_o = 1.5\text{ A}$ $V_i = 13.8\text{ V}$		4 30	8 50	mA
$\Delta I_Q$	Quiescent Current Change	$I_o = 5\text{ mA}$ $I_o = 1.5\text{ A}$ $V_i = 13.8\text{ to }16\text{ V}$			1.5 10	mA
$\frac{\Delta V_o}{\Delta T}$	Output Voltage Drift			1.2		mV/ $^\circ\text{C}$
SVR	Supply Voltage Rejection	$I_o = 1\text{ A}$ $f = 120\text{ Hz}$	55	61		dB
$V_d$	Dropout Voltage	$I_o = 0.5\text{ A}$ $I_o = 1.5\text{ A}$		200 500	400 900	mV
$I_{sc}$	Short Circuit Current	$V_i = 14\text{ V}$		2	2.7	A
$Z_o$	Output Impedance	$f = 1\text{ KHz}$ $I_o = 0.5\text{ A}$		40		m $\Omega$

Figure 4 : Dropout voltage vs. Output Current.

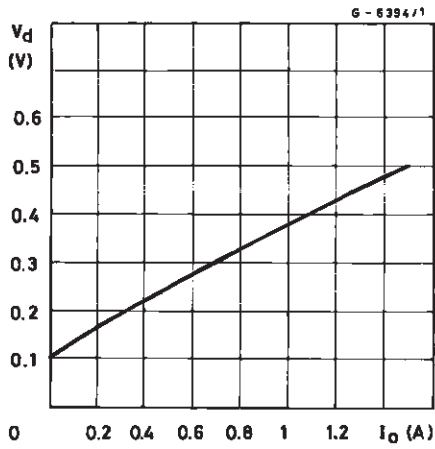

Figure 5 : Dropout Voltage vs. Temperature.

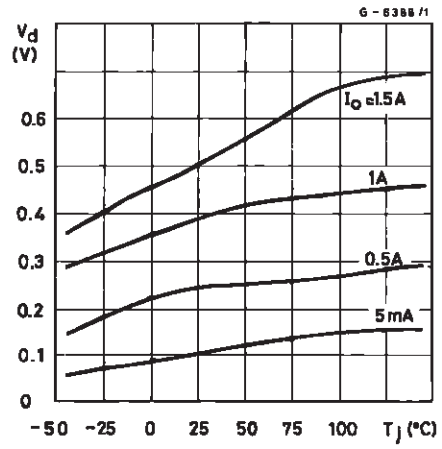

Figure 6 : Output voltage vs. Temperature (L4940V5).

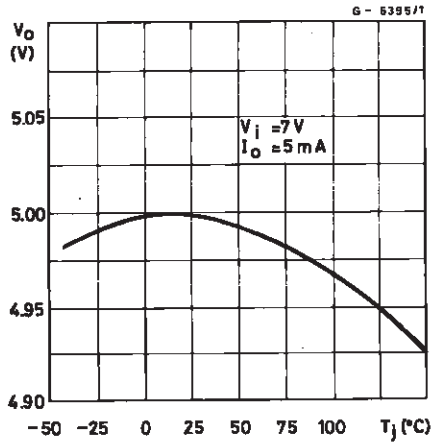

Figure 7 : Output Voltage vs. Temperature (L4940V85).

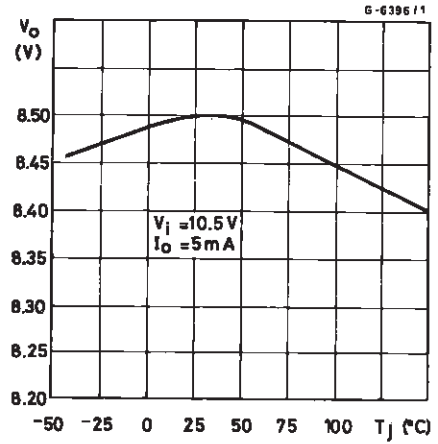

Figure 8 : Output voltage vs. Temperature (L4940V10).

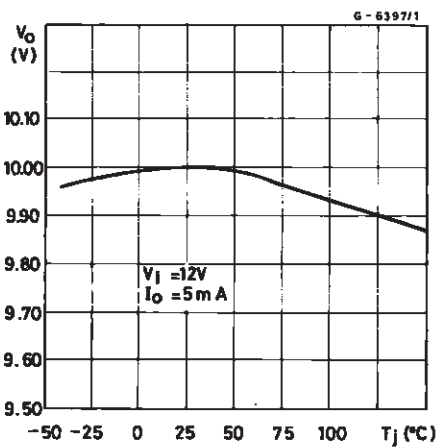

Figure 9 : Output Voltage vs. Temperature (L4940V12).

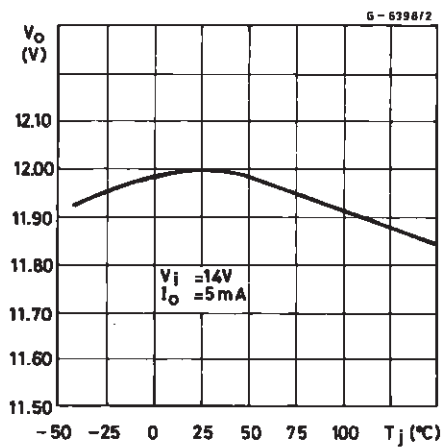

Figure 10 : Quiescent Current vs. Temperature (L4940V5).

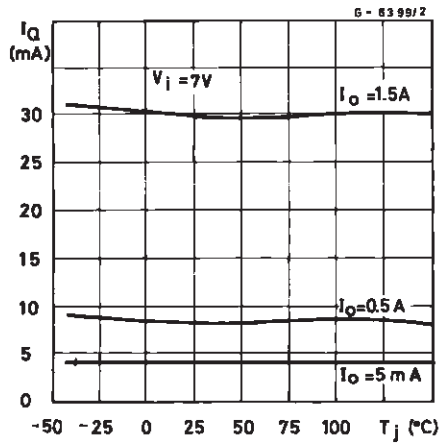

Figure 11 : Quiescent Current vs. Input Voltage (L4940V5).

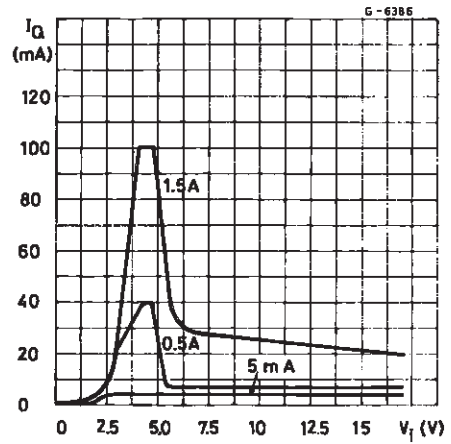

Figure 12 : Quiescent Current vs. Output Current (L4940V5).

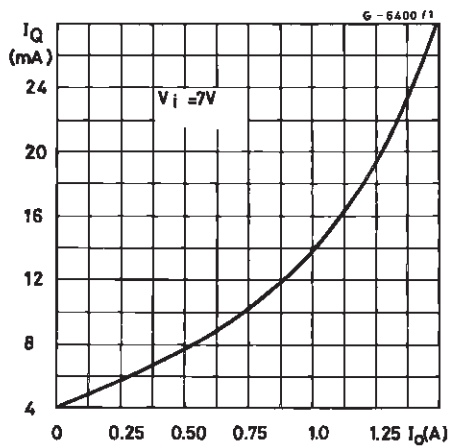

Figure 13 : Short-circuit Current vs. Temperature (L4940V5).

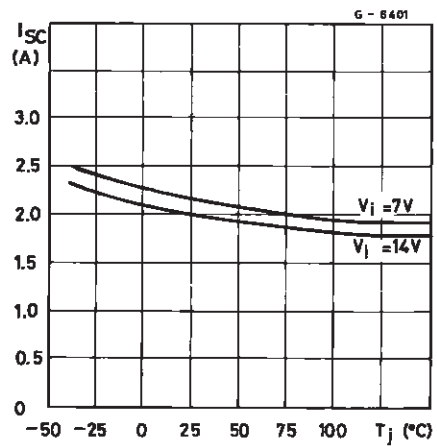

Figure 14 : Peak Output Current vs. Input/Output Differential Voltage (L4940V5).

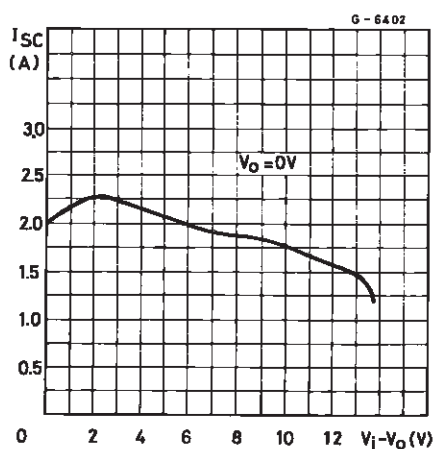

Figure 15 : Low Voltage Behavior (L4940V5).

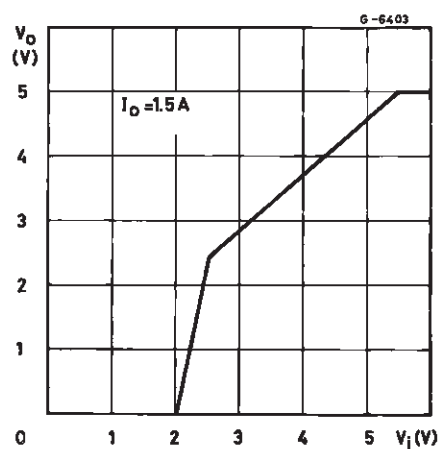

Figure 16 : Low Voltage Behavior (L4940V85).

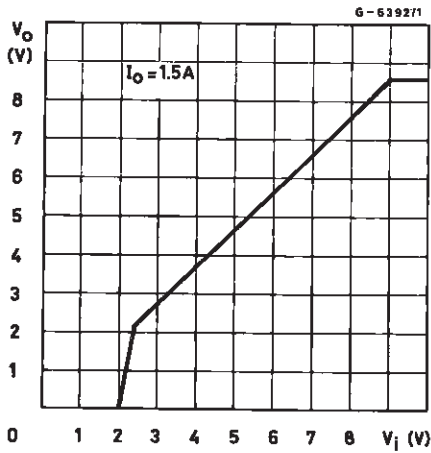

Figure 17 : Low Voltage Behavior (L4940V10).

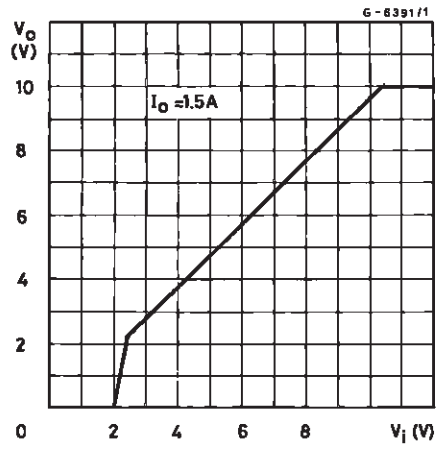

Figure 18 : Low Voltage Behavior (L4940V12).

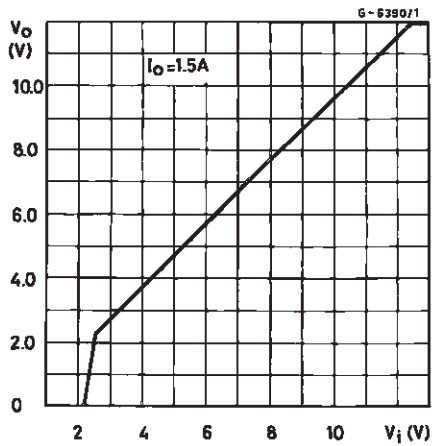

Figure 19 : Supply Voltage Rejection vs. Frequency (L4940V5).

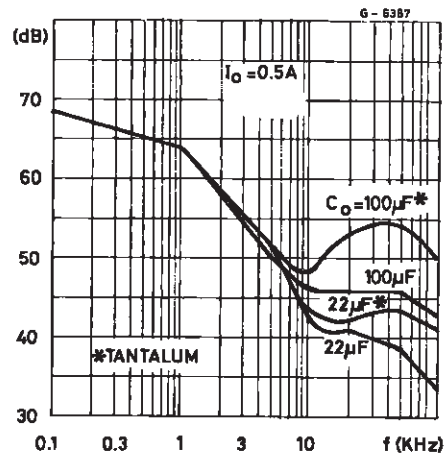

Figure 20 : Supply Voltage Rejection vs. output Current.

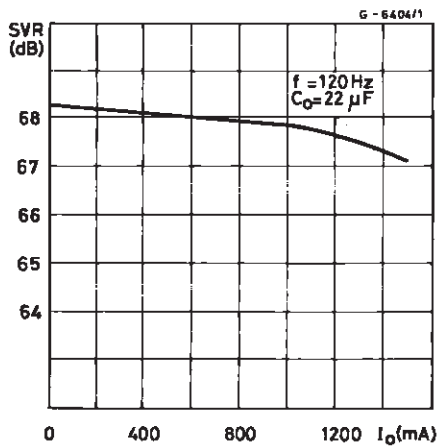

Figure 21 : Load Dump Characteristics (L4940V5).

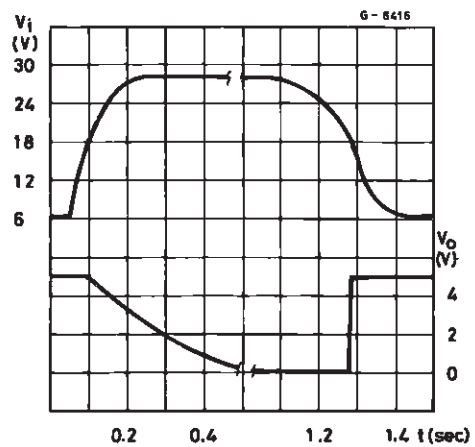
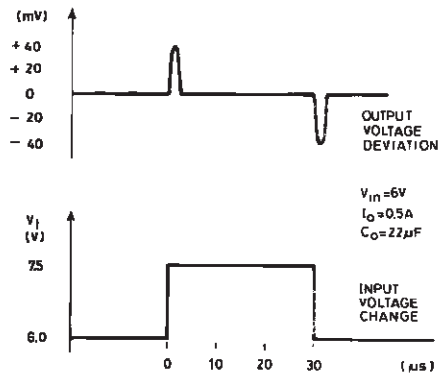



Figure 22 : Line Transient Response (L4940V5).



5-9461/1

Figure 23 : Load Transient Response.

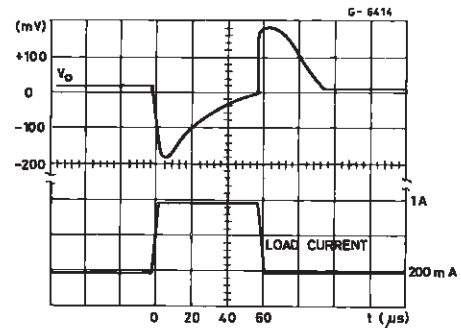

Figure 24 : Total Power Dissipation.

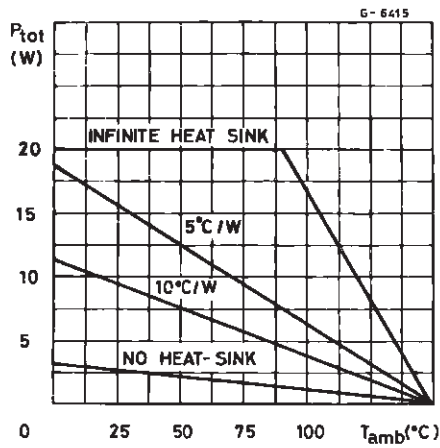
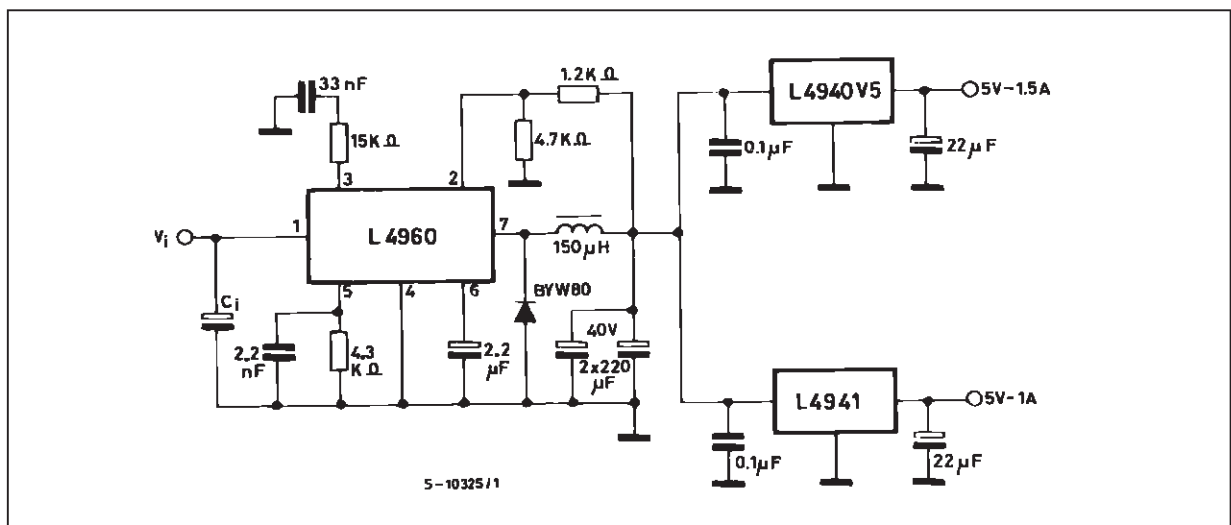

Figure 25 : Distributed Supply with On-card L4940 and L4941 Low-drop Regulators.





## TO-220 MECHANICAL DATA

DIM.	mm			inch		
	MIN.	TYP.	MAX.	MIN.	TYP.	MAX.
A			4.8			0.189
C			1.37			0.054
D	2.4		2.8	0.094		0.110
D1	1.2		1.35	0.047		0.053
E	0.35		0.55	0.014		0.022
F	0.61		0.94	0.024		0.037
F2	1.15		1.4	0.045		0.055
G	4.95	5.08	5.21	0.195	0.200	0.205
H2			10.4			0.409
H3	10.05		10.4	0.396		0.409
L2		16.2			0.638	
L3	26.3	26.7	27.1	1.035	1.051	1.067
L5	2.6		3	0.102		0.118
L6	15.1		15.8	0.594		0.622
L7	6		6.6	0.236		0.260
Dia.	3.65		3.85	0.144		0.152

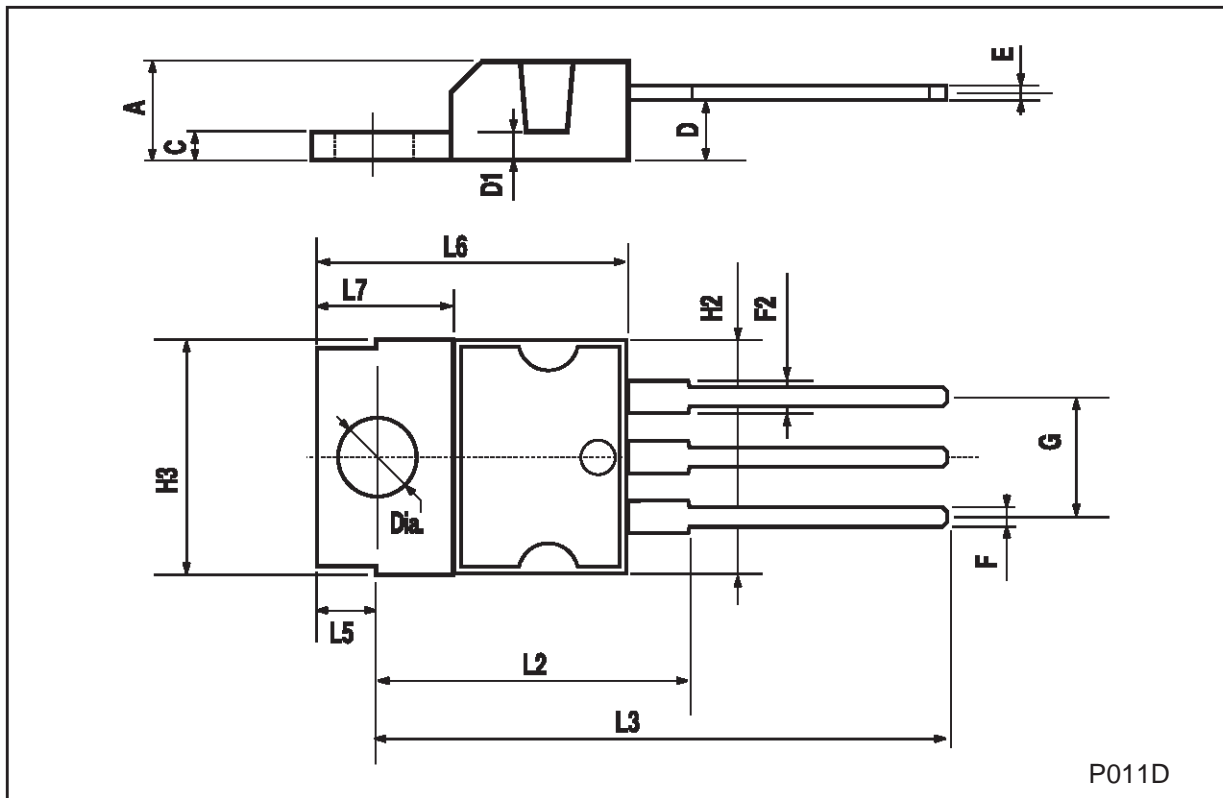

TO-263 (D<sup>2</sup>PAK) MECHANICAL DATA

DIM.	mm			inch		
	MIN.	TYP.	MAX.	MIN.	TYP.	MAX.
A	4.4		4.6	0.173		0.181
A1	2.49		2.69	0.098		0.106
B	0.7		0.93	0.027		0.036
B2	1.14		1.7	0.044		0.067
C	0.45		0.6	0.017		0.023
C2	1.23		1.36	0.048		0.053
D	8.95		9.35	0.352		0.368
E	10		10.4	0.393		0.409
G	4.88		5.28	0.192		0.208
L	15		15.85	0.590		0.624
L2	1.27		1.4	0.050		0.055
L3	1.4		1.75	0.055		0.068

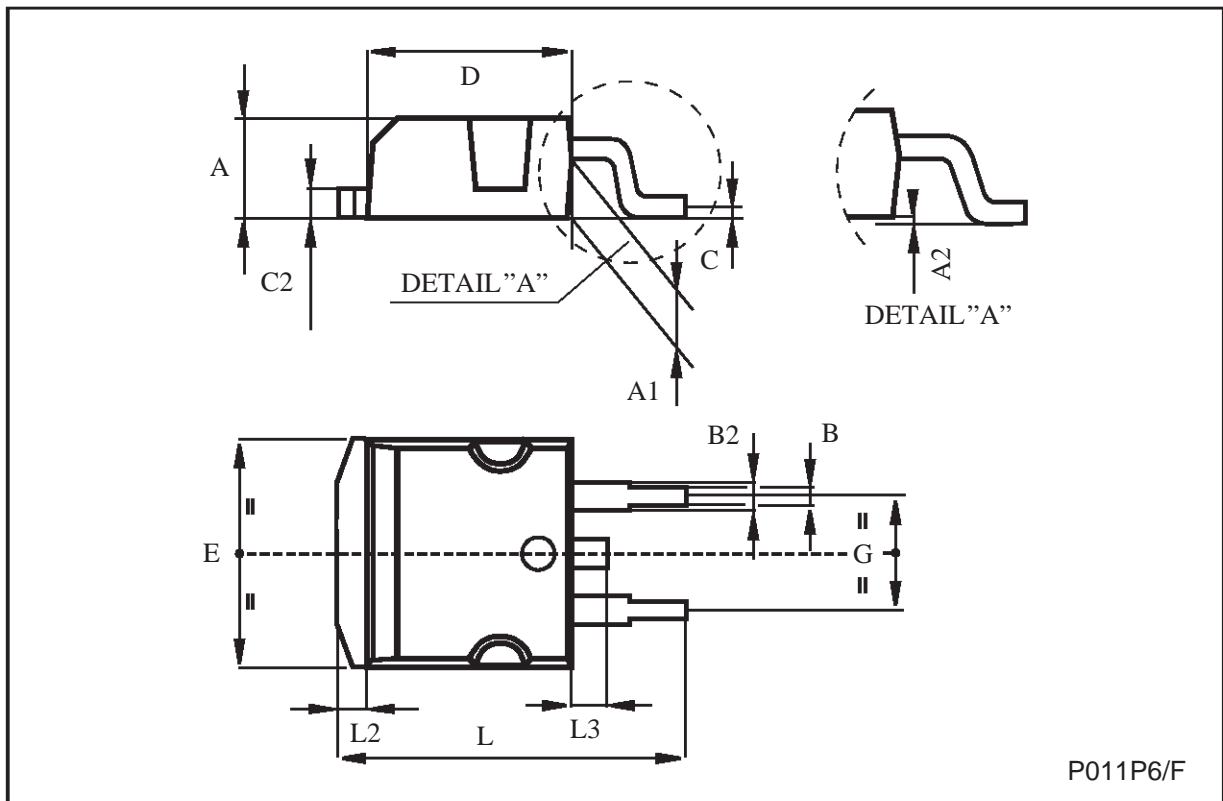

Information furnished is believed to be accurate and reliable. However, STMicroelectronics assumes no responsibility for the consequences of use of such information nor for any infringement of patents or other rights of third parties which may result from its use. No license is granted by implication or otherwise under any patent or patent rights of STMicroelectronics. Specification mentioned in this publication are subject to change without notice. This publication supersedes and replaces all information previously supplied. STMicroelectronics products are not authorized for use as critical components in life support devices or systems without express written approval of STMicroelectronics.

The ST logo is a registered trademark of STMicroelectronics

© 1999 STMicroelectronics – Printed in Italy – All Rights Reserved

STMicroelectronics GROUP OF COMPANIES

Australia - Brazil - China - Finland - France - Germany - Hong Kong - India - Italy - Japan - Malaysia - Malta - Morocco  
Singapore - Spain - Sweden - Switzerland - United Kingdom - U.S.A.

<http://www.st.com>

This datasheet has been download from:

[www.datasheetcatalog.com](http://www.datasheetcatalog.com)

Datasheets for electronics components.